



KANDI

KANDI KRUISER 4P ELEMENT ELECTRIC GOLF CART

OWNER'S MANUAL



www.KandiAmerica.com

OWNER'S MANUAL



WARNING

Before operating this vehicle, carefully read this manual and any owner's manual supplements.

THIS VEHICLE IS NOT INTENDED FOR USE ON RENTAL TRACKS OR FOR RACING.

Kandi Cruiser Electric Golf Cart

XC-B-2+2-1

Before operating this vehicle, the owner and anyone permitted to operate the vehicle must read and understand all instructions for safe operation of the vehicle, as specified in this owner's manual.



Kandi America

8050 Forest Lane, Dallas, TX 75243

Phone: (972) 271-0888

Email: support@kandiamerica.com

NOTE:

Please keep this manual in a safe place so that it is easily accessible and can be found and referenced when needed.

CONTENTS

1. Introduction	6
1.1 Important Safety Notices	7
1.2 Operating Procedures	8
2. Understanding Safety Warnings	12
2.1 Safety Alert Symbols	13
3. Vehicle Warning Decals	14
4. Vehicle Safety Alerts	17
5. Vehicle Identification Number (VIN)	25
6. Vehicle Display	26
6.1 Instrument Panel	26
Instrument Panel Feature Diagram	26
7. Vehicle Controls & Parts	27
7.1 Instrument Panel Switches	27
1. Gear switch	27
2. Key switch	27
3. Winch switch (optional accessory)	28
4. Hazard warning switch	28
5. Spotlight switch	28
USB charging port	28
7.2 Steering Column	29
Turn Signal Combination Switch	29
1. Turn signal	29
2. Horn switch	29
3. Running light switch	29
4. Low-beam switch	29

5. High-beam switch.....	29
7.3 Pedals	30
Accelerator & Brake Pedals.....	30
Parking Brake Pedal.....	31
7.4 Seatbelts	31
Proper Use of the Seatbelt	32
7.5 Trailer Hitch Receiver Bracket (Optional)	32
8. Safety Gear.....	33
8.1 Helmets	33
8.2 Eye Protection.....	33
8.3 Gloves	33
8.4 Boots	33
8.5 Clothing.....	33
9. Battery	34
9.1 Examining the Batteries	34
9.2 Avoiding Short Circuits	35
9.3 Charging.....	35
9.4 12V Starting Battery	36
9.5 Lithium-ion (LiFePO4) Battery.....	36
10. Maintenance	38
10.1 Pre-ride Inspection	38
10.2 Periodic Maintenance.....	41
10.3 Periodic Maintenance Schedule.....	42
10.4 Lubrication Recommendations.....	44
10.5 Periodic Maintenance Record	45
10.6 Maintenance Specifications.....	48
Torque Specifications for Lug Nuts	48

Steering	48
10.7 Camber and Caster	49
10.8 Toe Alignment Check.....	49
10.9 Brakes	50
Front Brakes	50
Rear Brakes.....	51
Parking Brake	51
10.10 Storage.....	51
11. Cleaning the Vehicle	52
11.1 Exterior Body Panels	52
11.2 Seats and Floorboard	52
11.3 Windshield and Lights	52
11.4 Wheels and Tires.....	53
11.5 Front Basket	53
11.6 Under-Seat Compartments.....	53
12. Transporting the Vehicle	54
12.1 Strap Down the Roof.....	54
12.2 Protect the Windshield	54
13. Troubleshooting	55
13.1 Contacting an Authorized Dealer or Service Center	55
13.2 Battery (12V) Troubleshooting.....	55
Replacing the 12V Battery	56
13.3 Symptoms and Possible Causes.....	56
Symptom: Vehicle alarm sounds while in forward gear	56
Symptom: Vehicle won't move.....	57
Symptom: Poor charging performance	58
Symptom: Poor braking	58

Operating performance issues.....	58
13.4 Fault Codes.....	59
Vehicle Specifications	61

1. Introduction

Congratulations on the purchase of your Kandi Cruiser 4P Element Electric Golf Cart. We take pride in offering you a product that is engineered and manufactured to the highest performance and quality standards. We are certain that you will enjoy its superior levels of performance, reliability, riding comfort, and safety.

This manual is provided to help owners and drivers become familiar with the operation of this vehicle and with its many features. This manual also covers information on the care and maintenance of your vehicle.

Please read this manual carefully. The information contained in this owner's manual, and the warning labels on the vehicle will help you to understand the safe use and maintenance of your vehicle. Make sure that you understand and follow all warnings and instructions.

If you did not receive any of the material listed above, please call your dealer to request a copy of these materials.

Product features and specifications are subject to change without notice.

For customer service, please email support@kandiamerica.com.

1.1 Important Safety Notices

This vehicle is designed and manufactured for off-road use only. It is illegal to operate this vehicle on any public street, road, or highway. Such use is prohibited by law, unless otherwise provided for by the local government.

Consult applicable laws and regulations before choosing a location to operate this vehicle. It is illegal to operate this vehicle on public lands where vehicles of this size are prohibited.

DO NOT modify the motor, drive system, mechanical or electrical systems of this vehicle. **DO NOT** install aftermarket parts or accessories intended to increase the speed or power of this vehicle.

Failure to follow these warnings will void the warranty on this vehicle and could result in **DEATH** or **SERIOUS INJURY**.

The addition and use of certain accessories including, but not limited to, mowers, blades, sprayers, winches and windshields will change the handling characteristics and the performance of this vehicle.

Practice Responsible Vehicle Operation

Ensure that you understand and comply with all applicable local, state, province, federal, and national laws and requirements.

Remember to respect your vehicle, respect the environment, and respect the property of others. When operating this vehicle, you are responsible for your own safety and the safety of others around you.

The 4P Element Electric Golf Cart can be hazardous to operate.

Golf carts handle differently from other vehicles such as motorcycles, ATVs and cars. If proper precautions are not taken, rollover can occur even during routine maneuvers such as turning, driving or turning while on a hill, or driving over an obstacle.

1.2 Operating Procedures**WARNING**

Ignoring the following instructions could result in serious injury or death.

Ensure that all drivers carefully read this owner's manual and all product labels and follow the operating procedures.

1. This vehicle is designed to carry a maximum of 1 driver and 3 passengers.
Do not operate this vehicle with more than 3 passengers.
2. The driver and all passengers **must** wear seat belts while the vehicle is in motion.
3. **Do not** allow persons under 18 years of age to operate this vehicle.
4. Before permitting a guest to operate this vehicle, ensure that the guest has read this owner's manual and all product labels.
5. For their own personal safety, the driver and all passengers **must** wear Department of Transportation (DOT) approved off-road motorcycle helmets that fit properly, eye protection (glasses or face shield), gloves, boots, a long-sleeved shirt or jacket, and long pants.
6. As with any off-road-capable vehicle, there is a risk of rollover under certain conditions. The risk of rollover can be increased by uneven terrain or slopes that pitch the vehicle sideways, by turning too fast or sharply, or by a combination of these conditions.

7. Persons inside the vehicle while it is rolling over **must** keep their arms and legs inside the vehicle and **must not** attempt to use their arms or legs to stop the vehicle from rolling over, as doing so could lead to serious injury. Hands, arms, legs, and feet can easily be crushed by the vehicle. Arms and legs must be kept inside the vehicle until comes to a complete stop.
8. The driver **must not** consume alcohol or drugs before or while operating this vehicle.
9. **Do not** drive this vehicle at excessive speeds. The driver must always operate the vehicle at a speed that is suitable for their level of experience, the terrain, visibility and operating conditions.
10. **Do not** attempt wheelies, jumps or any other stunts with this vehicle.
11. Drivers **must** always conduct a pre-trip inspection on the vehicle to make sure it is in safe operating condition. Make sure to follow the maintenance schedule, and the inspection and maintenance procedures described in this manual.
12. Keep hands, arms, feet, and legs inside the vehicle and feet on the floorboard **at all times** while the vehicle is in motion. Use the grab handle inside the vehicle when necessary. **Do not** hold onto the exterior of the vehicle. Hands holding onto the exterior of the vehicle can easily be crushed between the vehicle and an outside obstruction.
13. Drivers **must** keep both hands on the steering wheel when driving.
14. Drivers **must not** wrap their thumbs around the steering wheel. The steering wheel should be held with thumbs pointing up. This is particularly important when driving in rough terrain, as the front wheels will travel side to side as they respond to the terrain, and this movement will be felt in the steering wheel. A sudden jolt could wrench the steering wheel, and serious injury could occur.
15. When operating this vehicle on unfamiliar terrain, drivers **must** operate the vehicle slowly and exercise extra caution.

16. Stay aware of changing terrain conditions when operating this vehicle. **Do not** operate this vehicle on excessively rough, slippery or loose terrain.
17. Drivers must follow proper turning procedures as described in this manual. Practice turning at low speeds before attempting to turn at higher speeds. **Do not** attempt to turn at excessive speeds.
18. If this vehicle is involved in an accident, it **must** be inspected and serviced by an authorized dealer.
19. **Do not** operate this vehicle on hills that exceed the driver's ability to navigate or are too steep for the vehicle. Practice on smaller hills before attempting to operate this vehicle on larger hills.
20. Drivers **must** follow proper procedures for climbing hills as described in this manual. **Always** check the terrain carefully before attempting to ascend any hill. **Do not** attempt to ascend hills that have excessively slippery or loose surfaces. **Do not** accelerate suddenly or make sudden gear changes. **Do not** drive over the top of any hill at high speeds.
21. Drivers **must** follow proper procedures for descending and braking on hills, as described in this manual. Check the terrain carefully before descending any hill. **Do not** descend hills at high speed or at an angle which would cause the vehicle to lean sharply to one side. When possible, go straight down the hill.
22. Drivers **must** follow proper procedures for traveling across the side of a hill, as described in this manual. Avoid hills with excessively slippery or loose surfaces. While on a hill, **do not** attempt to turn this vehicle around. When possible, avoid traveling across the side of a steep hill.
23. Driver **must** use proper procedures when stalling or rolling backwards while ascending a hill. To avoid stalling, maintain a steady speed when ascending.
24. Drivers **must** always check for obstacles before operating on new terrain. **Do not** attempt to drive over large obstacles, such as large rocks or fallen trees.

Drivers **must** follow proper procedures when driving over obstacles, as described in this manual.

25. Drivers **must** take precautions to avoid skidding or sliding. On slippery surfaces, such as ice, operate the vehicle slowly and cautiously in order to reduce the chance of skidding or sliding.
26. **Do not** drive this vehicle through deep or fast flowing water. **Do not** attempt to enter water that exceeds the recommended maximum depth. When driving through water, drive slowly and carefully avoiding sudden movements. Maintain a slow and steady forward motion, and **do not** make sudden turns or stops, or make sudden changes to the vehicle speed.
27. Wet brakes may have reduced stopping ability. Brakes **must** be tested after leaving water. If necessary, apply the brakes lightly several times to allow friction to dry out the brake pads.
28. Drivers **must** ensure that there are no obstacles or people behind the vehicle when driving in reverse. When it is safe to drive in reverse, drive slowly. Avoid turning at sharp angles while driving in reverse.
29. This vehicle **must** be equipped with the proper size and type of tires specified in this manual. Always maintain proper tire pressure, as described in this manual.
30. Vehicle accessories **must** be installed properly. **Do not** attempt to use this vehicle with accessories that are installed or used improperly.
31. **Do not** exceed the stated load capacity of the vehicle. Cargo should be distributed evenly from side to side and secured so that it cannot move during the operation of the vehicle. Reduce speed, allow greater distance for braking, and follow the instructions in this manual for carrying cargo or pulling a trailer.

2. Understanding Safety Warnings

ATTENTION:

This vehicle is only intended for use by adults. This vehicle is not a toy.

READ AND UNDERSTAND THE OWNER'S MANUAL AND ALL WARNINGS BEFORE ATTEMPTING TO OPERATE THIS VEHICLE.



WARNING

Drivers must ensure that they fully understand this vehicle before attempting to operate it.

Drivers **must** read this manual thoroughly and reference the parts of the vehicle that are under discussion in each section. Operating this vehicle carries a responsibility for ensuring your own personal safety, the safety of others, and the protection of our environment.

NOTE: Illustrations used in this manual are intended for reference only. Features on the vehicle are subject to change at any time without warning.

2.1 Safety Alert Symbols

Safety alerts identify special instructions or procedures which, if not correctly followed, could result in personal injury, or loss of life. In order to remain safe, owners and drivers must read all safety alerts in this manual carefully.



This is the safety alert symbol. When this symbol is present on the vehicle or in this owner's manual, it signals the potential for personal injury. **Pay attention. Your safety and the safety of others is at stake.**

"WARNING" indicates a potential hazard that could result in serious injury or death:



"CAUTION" indicates a potential hazard that could result in minor personal injury or damage to the vehicle:



NOTE: In this owner's manual, the word "NOTE" highlights key information and instructions.

NOTE: Warning decals have been placed on the vehicle for your protection. Read and follow the instructions on each decal carefully. In the event any decal becomes illegible or becomes detached from the vehicle, contact your dealer to order a replacement.

3. Vehicle Warning Decals

Below are the warning decals that have been affixed to this vehicle.

1.

WARNING

Improper use can result in Severe INJURY or DEATH

<p>BE PREPARED</p> <ul style="list-style-type: none"> • Fasten seat belts. • Wear an approved helmet and protective gear. • Each rider must be able to sit with back against seat. <p>Feet flat on floor (and foot rests), and hands on steering wheel or handhold(s), [where equipped]. Stay completely inside the vehicle.</p> <p>Drive Responsibly</p> <p>Avoid loss of control and rollovers:</p> <ul style="list-style-type: none"> • Avoid abrupt maneuvers, sideways sliding, skidding, or fishtailing, and never do donuts. • Slow down before entering a turn. • Plan for hills, rough terrain, ruts, and other changes in traction and terrain. Avoid paved surfaces. • Avoid side hilling (ride across slopes). 	<p>Be Sure Riders Pay Attention and Plan Ahead</p> <p>If you think or feel the vehicle may tip or roll, reduce your risk to injury:</p> <ul style="list-style-type: none"> • Keep a firm grip on the steering wheel or handholds and brace yourself. • Do not put any part or your body outside of the vehicle for any reason. <p>Require Proper Use of Your Vehicle</p> <p>Do you part to prevent injuries:</p> <ul style="list-style-type: none"> • Do not allow careless or reckless driving. • Make sure operators are 16 or older with a valid driver's license. • Do not let people drive or ride after using alcohol or drugs. • Do not allow operation on public roads (unless designated for off-highway vehicle access)—collisions with cars and trucks can occur. • Do not exceed seating capacity:
--	---

[Locate and] Read [Owner's Manual]
Follow All Instruction and Warnings
[Reserved for Reference to Other Sources of Safety Information]



ALWAYS USE AN APPROVED HELMET AND PROTECTIVE GEAR



NEVER USE PUBLIC ROADS OR PAVEMENT



NEVER USE WITH DRUGS OR ALCOHOL

2.

WARNING

Improper tire pressure can cause the vehicle out of control, resulting in serious personal injury or death.

Always keep the tire pressure within the specified range.

• Tire pressure:

Front wheel: 12psi (87kPa)

Rear wheel : 14psi (93kPa)

3.



4.



5.



6.



7.



8.



4. Vehicle Safety Alerts

The following vehicle safety alerts address many common issues that may arise during the operation and maintenance of this vehicle. Ensure that all drivers read and understand these alerts before attempting to operate the vehicle. Failure to do so could potentially result in serious injury or death.

1.



WARNING

After a rollover or accident, this vehicle must be inspected and serviced by an authorized dealership or service center.

2.



WARNING

Operating this vehicle requires strong judgement and physical skills. Persons with cognitive or physical disabilities who operate the vehicle are at increased risk of overturning or losing control of the vehicle, which could result in serious injury or death.

3.



WARNING

Do not plug in or unplug electrical components while the vehicle is turned on. Failure to follow this instruction could result in serious injury or death.

Installing or removing electrical components while the vehicle is turned on can cause poor contact or an arc fault, which may cause in signal interference or damage to the electrical components or cause the driver to lose control of the vehicle, which could result in serious injury or death.

4.

**WARNING**

Washing the vehicle with a large amount of water or using a wet cloth to clean electrical components or batteries could result in serious injury or death.

Excessive water droplets on electrical components could cause short circuits, burn electrical circuits or components, cause fire or leakages, or cause other issues that could result in serious injury or death. A hose on shower setting using residential water pressure may be used on the exterior of the vehicle. Do not open the battery compartment while washing the vehicle or attempt to wash or rinse the battery or the inside of the battery compartment.

5.

**WARNING**

Driving a vehicle with a malfunctioning accelerator pedal could result in accident or injury.

A malfunctioning accelerator pedal may become difficult to operate, affecting the driver's ability to speed up or slow down when necessary, and could lead to an accident or injury. Drivers must always check the operation of the accelerator pedal before starting the engine. If the accelerator pedal is not working smoothly, correct the issue before operating the vehicle. If you are unable to locate or solve the problem on your own, contact an authorized dealer or service center for assistance.

6.

**WARNING**

Failure to wear a seatbelt or failure to wear the seat belt properly could result in serious injury or death.

Always ensure that the driver and all passengers wear their seatbelt properly when riding in the vehicle. A properly fitting seatbelt is close fitting across the hips and chest and is latched securely. In the event of an accident, failure to wear a seatbelt or failure to wear the seat belt properly increases the risk of serious injury and death.

7.

**WARNING**

Attempting to stop the vehicle from rolling over could result in serious injury.

As with any off-road capable vehicle, this vehicle is at risk of rollover in certain conditions. Uneven terrain or slopes that pitch the vehicle sideways, turning too fast or too sharp, or a combination of these conditions, can increase the risk of vehicle rollover. If the vehicle is tipping, do not attempt to put your arms or legs outside the vehicle or try to use your arms or legs to stop the vehicle from tipping over. Doing so could lead to crushed hands, feet, arms, or legs, or other serious injury. All occupants must keep their arms and legs inside the vehicle until it stops moving.

8.

**WARNING**

Attempting to drive the vehicle with malfunctioning brakes could result in accident or injury.

Always check the brakes before operating the vehicle. Do not attempt to operate a vehicle that has brakes that are functioning improperly. If the brake function cannot be corrected using the adjustment procedures provided in this owner's manual, the vehicle must be inspected and serviced by an authorized dealer or service center.

9.

**WARNING**

Operating the vehicle without being familiar with all controls could lead to a loss of control, resulting in accident or injury.

Read the owner's manual carefully. If there is any aspect of the vehicle or vehicle operation that you do not understand, please contact an authorized dealer or Kandi customer service.

10.

**WARNING**

Improper charging could result in serious injury.

Charge the battery using the supplied charging cable. Disconnect the power supply when the light on the charging indicator turns green. If the charging indicator, charging socket, or charging cable are faulty and will not charge the vehicle battery, please contact an authorized dealer or service center.

11.

**WARNING**

Improperly installed accessories and improper modifications can change the way this vehicle handles, which could lead to an accident.

Do not attempt to operate this vehicle if it has improperly installed accessories or improper modifications. All parts and accessories on this vehicle must be genuine parts or equivalent components specifically intended for use on this vehicle and must be installed and used according to manufacturer instructions. If you have any questions, please contact an authorized dealer or service center.

12.

**WARNING**

Operating or riding in this vehicle without wearing a DOT approved helmet, eye protection, and protective clothing could result in serious injury or death.

Drivers and all passengers must always wear a properly fitting Department of Transportation (DOT) approved off-road motorcycle helmet, eye protection, gloves, boots, a long-sleeved shirt or jacket, and long pants. Failure to wear a DOT approved helmet could result in severe head injury or death in the event of an accident. Failure to wear eye protection, gloves, boots, a long-sleeved shirt or jacket, and long pants could result in serious injury in the event of an accident.

13.

**WARNING**

Consuming drugs or alcohol before or while operating this vehicle could result in serious injury or death.

Never consume drugs or alcohol before or while operating this vehicle. Drugs and alcohol can seriously affect the driver's judgement, slow their reaction time, affect their balance and perception, and could result in an accident.

14.

**WARNING**

Operating this vehicle at excessive speeds increases the chance of losing control of the vehicle and could result in an accident.

Always travel at a speed that is suitable for your level of experience, the terrain, visibility, and operating conditions.

15.

**WARNING**

Failure to properly maintain the vehicle or inspect the vehicle before operation increases the possibility of vehicle damage and accidents.

Always follow the procedures and schedules for inspection and maintenance that are described in this owner's manual. Always inspect the vehicle before operation to ensure that it is safe operating condition. Failure to properly maintain the vehicle or inspect the vehicle before operation increases the possibility of vehicle damage and accidents.

16.

**WARNING**

Removing your hands from the steering wheel or feet from the floorboard during operation of the vehicle can result in accident or injury.

Removing even one hand from the steering wheel or one foot from the floorboard can reduce the driver's ability to control the vehicle, and doing so could cause the driver to lose their balance and fall out of the vehicle. Always keep both hands on the steering wheel and both feet on the floorboard of your vehicle during operation.

17.

**WARNING**

Failure to use extra caution when operating this vehicle on unfamiliar terrain can cause the vehicle to overturn or cause the driver to lose control.

When operating the vehicle on unfamiliar terrain, go slowly and exercise caution. It is easy to encounter hidden rocks, bumps, or holes without enough time to properly react. Always be aware of changing terrain conditions when operating the vehicle.

18.

**WARNING**

Turning the vehicle improperly may cause the driver to lose control of the vehicle, which could result in accident or injury.

Always follow proper turning procedures, as described in this owner's manual. Practice turning at low speed before attempting to turn at higher speeds. Do not turn the vehicle at excessive speeds.

19.

**WARNING**

Improperly operating the vehicle over obstacles could cause a loss of control, collision, or cause the vehicle to overturn.

Check for any obstacles before operating the vehicle in a new area. Do not attempt to drive this vehicle over large obstacles, such as large rocks or fallen trees. If you are unable to avoid an obstacle, always follow the proper procedures as described in this owner's manual.

20.

**WARNING**

Skidding or sliding on slippery surfaces may cause the driver to lose control of the vehicle. While sliding or skidding, the vehicle may suddenly regain traction, which can cause the vehicle to overturn.

On slippery surfaces, such as ice, go slowly and be very cautious in order to reduce the chance of skidding or sliding out of control. While skidding or sliding, the vehicle may suddenly regain traction, which can cause the vehicle to overturn and could result in serious injury or death.

21.

**WARNING**

Operating this vehicle through deep or fast-flowing water could result in accident or injury.

Never operate the vehicle in water that exceeds the recommended maximum depth listed in this manual, or through fast-flowing water. Doing so may cause the tires to float, which can cause a loss of traction and loss of control that could result in an accident. If you cannot avoid a water obstacle, go slowly, balance your weight carefully, avoid sudden movements, and maintain a slow and steady forward motion. Do not make sudden turns or stops, and do not accelerate suddenly.

NOTE: Wet brakes have reduced stopping ability. Always test your brakes after leaving the water and, if necessary, apply the brakes lightly several times to allow friction to dry out the brake pads.

22.

**WARNING**

Use of improper tires or tires that have improper or uneven tire pressure, could cause a loss of control and increase the risk of an accident.

Always use the size and type of tires that are specified in this owner's manual. Before operating the vehicle, ensure that the tires inflated to the proper tire pressure. When seating the tire beads, always use the proper tire pressure that is specified on the sidewall of the tire. Exceeding the specified tire pressure could cause the tire to burst. Inflate the tires slowly and carefully, as rapid inflation could cause the tire to burst.

6. Vehicle Display

6.1 Instrument Panel

This vehicle has a 7-inch display that turns on automatically when the vehicle is started and functions as the instrument panel.

Instrument Panel Feature Diagram

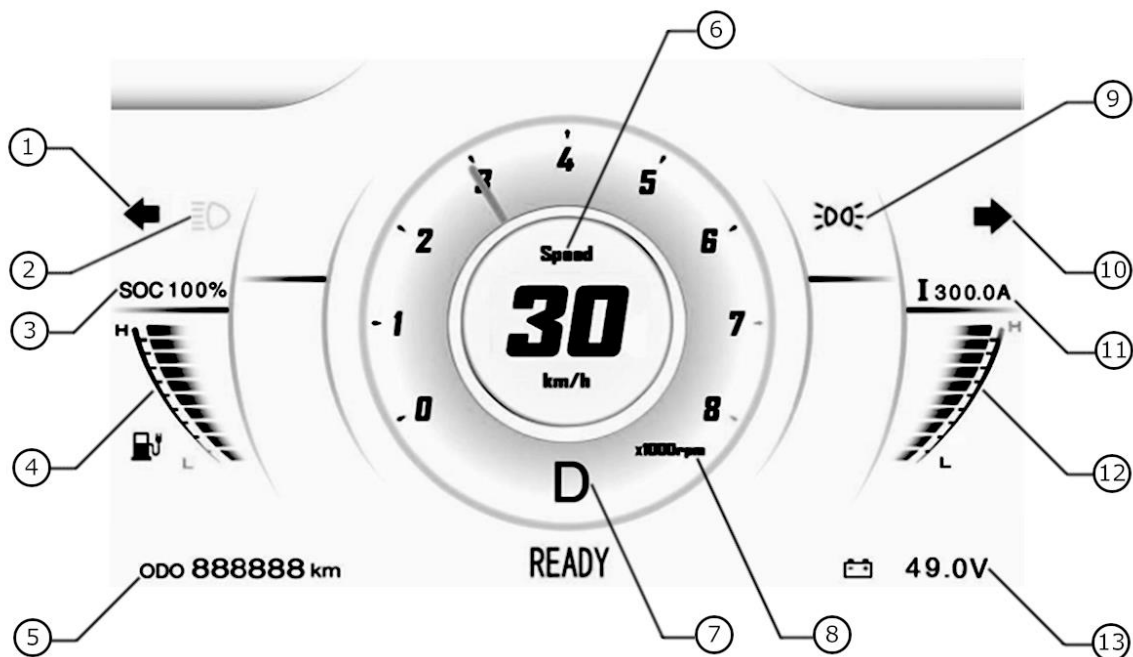

1. Left turn signal

6. Speed

9. Position lights

2. High beam headlights

7. Gear position

10. Right turn signal

3. State of charge

8. Motor speed

11. Electrical current

4. Electricity meter

12. Ampere meter

5. Total mileage

13. Battery voltage

7. Vehicle Controls & Parts

7.1 Instrument Panel Switches

1. Gear switch

Forward: When the vehicle is put into forward gear and the accelerator pedal is depressed, the vehicle will move forward.

Neutral: When the vehicle is put into neutral gear and the accelerator pedal is depressed, the vehicle will not move.

Reverse: When the vehicle is put into reverse gear, the backup camera image will replace the instrument panel display, the vehicle motion alarm will sound, and when the accelerator pedal is depressed, the vehicle will move in reverse.

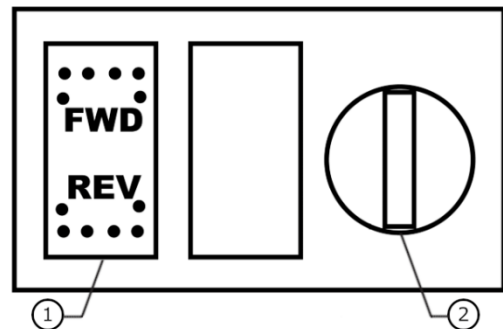

2. Key switch

ON: Provides 48V electric power supply for operation.

OFF: All circuits are turned off, and the key can be removed.

3. Winch switch (optional accessory)

If the optional winch accessory is installed on the vehicle, it will be controlled by this switch.

4. Hazard warning switch

This switch activates the hazard warning lights, which are used when the vehicle could become a potential hazard for other vehicles.

5. Spotlight switch

This switch activates the spotlight located on the front of the vehicle.

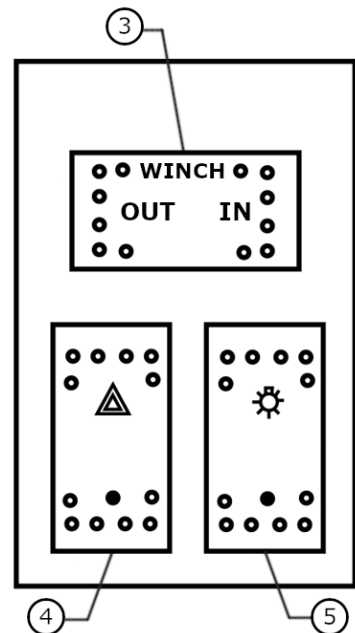

USB charging port

The USB charging port is located on the passenger side of the dashboard.

The charging port is rated for 5V2A, and exceeding this rating will trip the fuse.

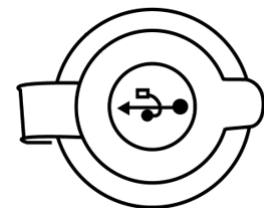

When washing the vehicle, do not allow water to enter the charging port.

7.2 Steering Column

Turn Signal Combination Switch

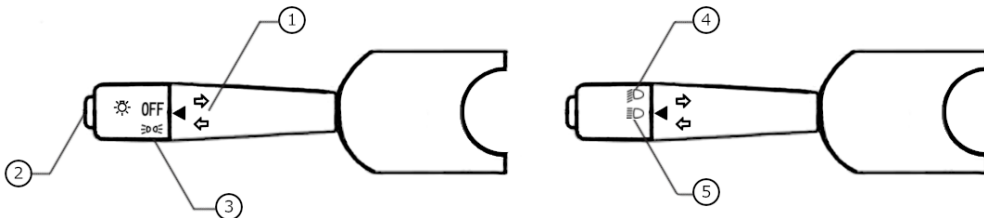

- 1. Turn signal:** Pull the switch up to activate the right turn signal or down to activate the left turn signal
- 2. Horn switch:** Depress the button on the end of switch to activate the horn
- 3. Running light switch:** Twist the switch forward one click to activate the running lights
- 4. Low-beam switch:** Twist the switch forward two clicks to activate the low-beam headlights
- 5. High-beam switch:** Twist the switch forward three clicks to activate the high-beam headlights

7.3 Pedals

Accelerator & Brake Pedals

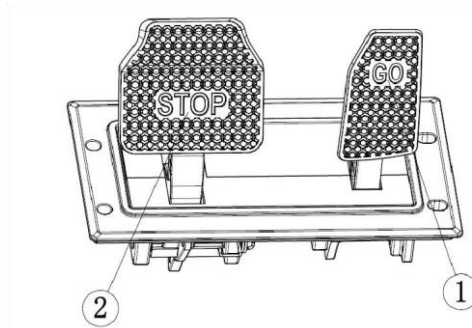

1. Accelerator pedal

Before turning on the vehicle, depress the accelerator pedal to make sure that it moves smoothly and returns to the idle position when released. Depress the accelerator pedal to increase the speed of the vehicle.

2. Brake pedal

Depress the brake pedal to slow or stop the vehicle. When the brake pedal is depressed, the brake lights in the rear of the vehicle light up.



WARNING

Spongy-feeling brakes can lose braking power and result in an accident.

Parking Brake Pedal

The parking brake pedal is located on the driver's side on the far left and is intended to be used to keep the vehicle motionless while it is parked. To release the parking brake, firmly depress the parking brake pedal.

If the vehicle is taken out of neutral gear and put in forward or reverse gear while the parking brake is engaged, the vehicle motion alarm will sound. Releasing the parking brake will silence the alarm.

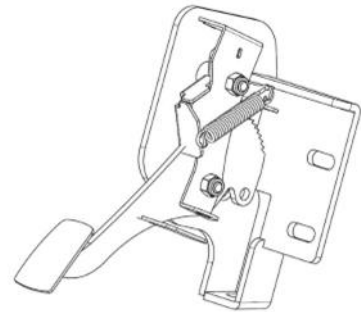

CAUTION

Failure to fully release the parking brake before operating the vehicle can lead to poor performance and excessive wear of the brake pads.

7.4 Seatbelts

This vehicle is equipped with three-point seatbelts for the driver and passengers.

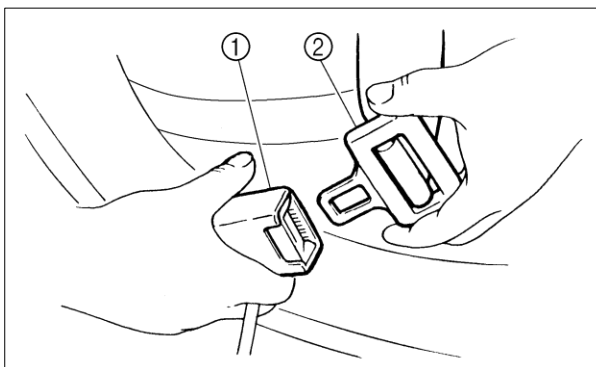

1. Seatbelt buckle
2. Latch plate

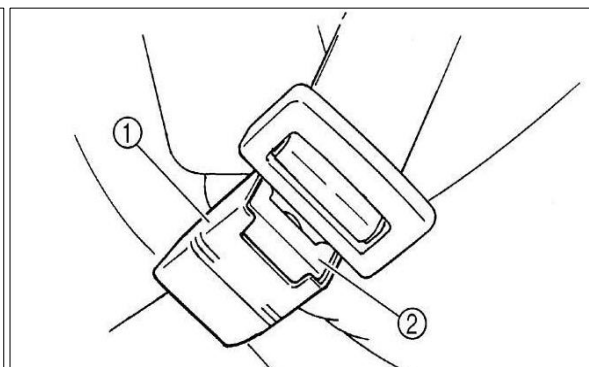

1. Seatbelt buckle
2. Release button

Proper Use of the Seatbelt

1. While holding the latch plate, pull the belt across your lap and chest. Ensure that the seatbelt is not twisted or caught on the vehicle, your clothing, or any equipment you are carrying.
2. Push the latch plate into the buckle until you hear an audible click. Pull up on the latch plate to check that it is secure.
3. The lap portion of the seatbelt should sit low on your hips. Ensure that the seatbelt is snug against your hips by pulling any slack out of the lap portion by pulling up on the shoulder portion of the seatbelt.
4. Position the shoulder portion of the seatbelt over your shoulder and across your chest. The shoulder portion of the seatbelt should fit snugly against your chest. If the shoulder portion of the seatbelt still feels loose, pull the seatbelt out as far as it can go, then let it retract.
5. To release the buckle, firmly press the release button.



WARNING

In the event of an accident, failure to wear a seatbelt or wear the seatbelt properly increases the risk of serious injury or death.

7.5 Trailer Hitch Receiver Bracket (Optional)

This vehicle can be fitted with a trailer hitch receiver bracket for a standard trailer hitch. A hitch extender may be required if the rear footrest is not removed for easier access.

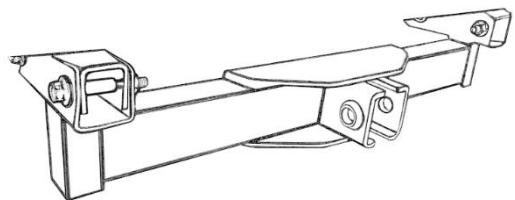

Note: Removing the rear footrest will also remove supports for the rear flip seat. The rear flip seat should not be used for passengers or cargo without all four supports installed.

8. Safety Gear

Always wear clothing that is suitable for the manner in which you are using the vehicle. Wearing special protective clothing will help you to feel more comfortable and reduce the chance of injury.

8.1 Helmets

A helmet is the most important piece of protective equipment that you can wear. Helmets are the best protection against serious head injuries. When selecting a helmet, always select a DOT approved off-road motorcycle helmet that fits properly.

8.2 Eye Protection

Protective goggles or a helmet face shield are the best options for protecting your eyes.

8.3 Gloves

Off-road-style gloves provide important protection for your hands.

8.4 Boots

Tall, hard-soled boots with tough heels that cover the calf, such as motocross boots, provide important protection for your lower extremities.

8.5 Clothing

Long sleeves and pants should always be worn when operating or riding in this vehicle. Protective motocross clothing that includes padding for your knees and shoulders offers the best protection.



WARNING

Operating this vehicle without a DOT approved motorcycle helmet and eye protection could result in serious injury or death.

9. Battery

This vehicle is equipped with a 51.2V 100Ah lithium iron phosphate battery, housed in a single steel enclosure, and a standard 12V starting battery. The batteries are located in the compartment below the front seat. The longevity of the batteries in this vehicle is directly related to battery use and maintenance.



WARNING

Never attempt to pierce or modify the batteries, as this could result in serious injury or death.

9.1 Examining the Batteries

It is important to regularly check the appearance of the batteries and the battery connections:

1. Check the external surface of both the 12V battery and lithium-ion battery enclosure for deformation or cracks (**do not attempt to open the lithium-ion battery enclosure**). The surface of the battery should be flat, dry, and free from any damage. **If there are any irregularities, do not attempt to turn on or operate the vehicle.** Contact an authorized dealer or service center to have the battery inspected and serviced.
2. Check the connection wires and terminals of the 12V battery for any signs of corrosion. If corrosion is present, clean the terminals and connectors. A corrosion inhibitor can be used to minimize corrosion.
3. Check to make sure that the terminals are secure by grasping the connected cable several inches from any metal parts, and gently moving the cable. Do not attempt to grab the fastener or battery terminal with any tools. **If either battery terminal is loose, do not attempt to turn on or operate the vehicle.** Contact an authorized dealer or service center to have the battery inspected and serviced.

9.2 Avoiding Short Circuits



WARNING

A short circuit could lead to an explosion that could result in serious injury or death.

The current of a short circuit can reach thousands of amperes and generate high amounts of heat that can damage the battery, cause battery leakage, or even cause an explosion that could result in serious injury or death.

Short circuits can be avoided by exercising extreme caution when installing or removing batteries, and when using battery installation tools. Exercise caution when handling the battery cables, as an improperly placed battery cable could cause a short circuit.

The battery terminals should be covered with an insulating cap, and the battery cables should not be allowed to overlap, as this can produce unwanted pressure on the cables and battery terminals.

9.3 Charging

The appropriate charging cable has been provided with this vehicle. Only the original charging cable should be used with this vehicle. If a replacement charging cable is required, use a genuine Kandi charging cable obtained either from an authorized dealer or service center, or directly from Kandi.

Depending on the model year of the vehicle, the charging socket is located either on the outside of the vehicle below the driver's seat, or on the base of the rear seat on the driver's side. The charging voltage for this vehicle is 110V.

Before attempting to charge the vehicle, check the charging socket and charging cable plug for damage, stains, or water stains. If there are any abnormalities, **do not attempt to charge the vehicle**. Contact an authorized dealer or service center to have the battery inspected and serviced.

When the charging display shows that the battery has reached 100%, the battery is fully charged, and the charging cable should be unplugged.

9.4 12V Starting Battery

This vehicle has a 12V starting battery. The 12V battery is charged by the lithium-ion battery while the vehicle is powered on, regardless of whether the vehicle is moving or stationary. The lithium-ion battery **cannot** charge the 12V starting battery while the vehicle is powered off.

When storing the vehicle for a longer than a few days, the 12V starting battery must either be checked weekly and topped off or connected to battery maintainer that is appropriate for the battery type.

9.5 Lithium-ion (LiFePO4) Battery

It is not recommended for the vehicle's lithium-ion battery to be stored for an extended period of time without charging. When storing the vehicle, is important to be mindful of the state of charge (SOC) on the lithium battery and prevent the SOC from dropping below 30%. Before storing the vehicle, ensure that the battery is fully charged.

Storing the vehicle with a battery that is fully depleted will cause **irreversible damage** to the battery. The longer the battery is stored in a fully discharged state, the more serious the damage to the battery. The lithium battery does not need to be connected to a battery maintainer.

The steel enclosure of the lithium-ion battery should be kept clean, and the vehicle should be parked in a location that is cool, dry, and well-ventilated. The lithium-ion battery should not be exposed to the sun. Sun exposure will increase the temperature of the battery and reduce the battery life.

To prolong the life of the battery, avoid fully depressing the accelerator pedal immediately after turning on the vehicle. Doing so can cause the motor current to rapidly increase and cause the battery to discharge too quickly, which can cause a drop in voltage that will result in reduction in battery life.

It is normal for the battery capacity to decrease as the temperature decreases. At temperatures of -10°C (14°F), the battery capacity will typically be 80%.

Do not attempt to charge lithium (LiFePO₄) batteries at temperatures below 0°C . While the lithium battery can be used in below-freezing temperatures, the internal battery temperature must remain above 0°C (32°F) while the battery is charged.

**CAUTION**

Charging a LiFePO₄ lithium battery at temperatures below 0°C (32°F) will irreparably damage the battery.

10. Maintenance

10.1 Pre-ride Inspection

	<p>WARNING</p>	<p>Before operation, the vehicle must be inspected to ensure that it is in proper working order. Failure to do so could result in serious injury or death.</p>
---	-----------------------	--

Before attempting to operate this vehicle, use the following checklist to verify that the vehicle is in proper working order:

1.	Tires	Check the condition of the tires and ensure that all tires are inflated to the correct pressure.
2.	Battery	Check for any battery abnormalities, make sure the wiring is secure, and the battery terminals are properly protected.
3.	Brakes	Check the fluid level, operation, and adjustment for all brakes, including the parking brake.
3a.	Brake pedal	Check the operation of the brake pedal and ensure that it has the proper amount of free play. The brake pedal should move smoothly and should feel firm when the brakes are applied. If the amount of free play is incorrect or there are any other issues with the brake pedal, the vehicle must be inspected and serviced by an authorized dealer or service center.

3b.	Brake fluid leakage	Check for any brake fluid leakage from the brake lines, brake hoses, or brake fluid reservoir by applying the brakes firmly for one minute. If there is any leakage, the vehicle must be inspected and serviced by an authorized dealer or service center.
3c.	Brake fluid level	Check the brake fluid level and add brake fluid when necessary.
3e.	Brake operation	Test the brakes at low speed to make sure that they are working properly. If they do not perform properly, inspect the braking system.
4.	Accelerator pedal	Check that the accelerator pedal operates freely with the correct amount of free play. The accelerator pedal must operate smoothly and fully spring back to its idle position when released. If the accelerator pedal does not perform properly, it must be inspected and serviced by an authorized dealer or service center.
5.	Lights	Check that headlights, taillights, and brake lights and their switches are operational.
6.	Wheels	Check that all wheel nuts and axle nuts are tightened appropriately and are secured with cotter pins. If there is damage to the wheels, or the bearing assemblies are loose or damaged, the vehicle must be inspected and serviced by an authorized dealer or service center.

7.	Steering	Check that the steering system operates freely and check for any unusual looseness. Park the vehicle on level ground and turn the steering wheel in both directions. Check for excessive free play, abnormal noises, or a rough feeling. If there are any abnormalities, the vehicle must be inspected and serviced by an authorized dealer or service center.
8.	Loose parts	Visually inspect the vehicle for any damaged components or any loose nuts, bolts, or fasteners. Always check the tightness of the chassis fittings and fasteners before operation. Loose parts must be tightened by a dealer or authorized service center to ensure proper tightening torque.
9.	Safety gear	Ensure that the driver and all passengers are wearing helmets, eye protection, and proper clothing.
10.	Seat belts	Check that seat belts are worn properly and are not frayed or damaged. Seat belts must move smoothly when pulled and retract on their own when released. The latch plate should click securely into the buckle and release when the release button is pressed firmly. Any dirt or mud must be removed to ensure that it does not interfere with seat belt operation. If there are any abnormalities, the vehicle must be inspected and serviced by an authorized dealer or service center.

10.2 Periodic Maintenance

Careful periodic maintenance will help keep your vehicle in the safest, most reliable condition. The inspection, adjustment, and lubrication intervals for important components are explained in the chart on the following pages.

Note:

This maintenance schedule is based on average driving conditions and an average vehicle speed of approximately 10 mph (16 km/h). Vehicles that are stored for an extended length of time should continue to be maintained according to the monthly maintenance intervals.

Vehicles used in severe conditions, such as dirty, dusty, or wet conditions, must be maintained more frequently in order to remove any water or dirt that could affect grease fittings or other critical components.

Inspect, clean, lubricate, adjust, or replace parts as necessary.

Note:

Inspection may reveal the need for replacement parts. Always use genuine Kandi parts, which are available from your dealer and directly from Kandi.

Vehicle service and adjustments are critical to the safe operation of this vehicle. If you are not familiar with the procedures necessary to safely service and adjust your vehicle, always have these procedures performed by an authorized dealer or service center.

10.3 Periodic Maintenance Schedule



WARNING It is recommended for inspections and adjustments marked with a “D” on the following chart to be completed by an authorized dealer or service center.

NOTE: Hours are based on an average of 10 mph (16 km/h)

For items listed with both hours of operations and months, perform maintenance based on interval that occurs soonest. When performing the monthly service intervals, make sure to also complete items listed in all preceding sections, e.g. daily maintenance items should be included during monthly maintenance.

✓ Check
★ Clean, adjust
D See dealer for service
■ Replace

Daily (see pre-ride inspection section for additional details)		
✓	Tires	Check tire condition and inflation
✓	Battery	Check for abnormalities, loose wiring
✓	Braking system	Check general operation, fluid level, adjustment for all brakes, including parking brake
✓	Electronic accelerator pedal	Check for smooth operation, full return to idle position
✓	Lights	Check that headlights, taillights, brake lights, and light switches are operational
✓	Wheels	Check that all fasteners are tight
✓	Steering	Check for free movement, no unusual looseness
✓	Frame nuts, bolts, and fasteners	Check by visually inspecting for looseness
✓	Seat belts	Check seatbelt condition, retraction of seat belts
✓	Charging cable	Check that the charging cable and charging socket are operating normally, recharge vehicle after ride

✓ Check ⊛ Clean, adjust **D** See dealer for service ■ Replace

Monthly or every <u>10</u> hours		
✓ D	Wheel bearings	Check for looseness or damage, tighten if loose, replace if damaged
✓ D	Brake pad wear	Inspect periodically
✓ D	Front wheel spindles	Check for looseness or damage of bearings and seals
✓	Rear gear case oil	Check for leaks, check level
Monthly or every <u>20</u> hours		
✓	Transmission fluid	Check for leaks, check level
⊛	Battery	Clean terminals, check for damage or deformation
Every <u>3</u> months or every <u>50</u> hours		
⊛	General lubrication	Lubricate all fittings, pivots, cables, etc.
Every <u>6</u> months or every <u>50</u> hours		
✓ D	Steering system	Check operation, check for looseness, wear, damage, binding feeling, then adjust, repair, or replace, when necessary. Check toe alignment / adjust if necessary
✓	Rear axle	Inspect bearings, lube
✓ ⊛	Front suspension	Inspect, lubricate, tighten fasteners
✓ ⊛	Rear suspension	Inspect, tighten fasteners
Every <u>24</u> months or every <u>200</u> hours		
D	Brake fluid	Change the brake fluid
Change Annually		
■	Transmission fluid	
■	Rear gear case oil	
As Required		
✓	Headlight focus	Adjust if necessary

10.4 Lubrication Recommendations

For items listed with both hours of operations and months, perform maintenance based on interval that occurs soonest.

	Item	Recommended Lube	Method	Frequency
	Brake fluid	DOT 3 or DOT 4	Should be about 2/3 full	As required, every 200 hours or every 2 years
	Gearbox oil	SAE 80W/90GL5	Add to proper level on dipstick	Change at 100 hours or annually
	Steering system	Grease	Lubricate the pivoting and sliding parts	50 hours or every 3 months
	Tie rods	Grease	Grease tie rods	Semi-annually
	Front wheel bearings	Inspect	Inspect and replace bearings if necessary	Semi-annually
	Ball joints	Grease	Locate, inspect fittings, grease or replace bearings if necessary	Semi-annually
	Rear axle bearing	Grease	Grease	50 hours or every 3 months

10.6 Maintenance Specifications

The tightness of the following items should be checked both periodically and after being loosened for service, and should always be adjusted to the specifications listed below.

Torque Specifications for Lug Nuts

NOTE: Nuts that have a cotter pin installed must **only** be serviced by an authorized dealer or service center.

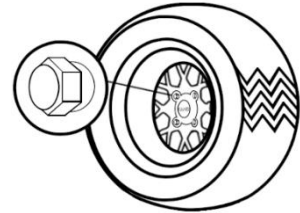

Bolt Size	Specification	
M12 x 1.25	50 ft/lb	69N/m

Steering

Steering Inspection

The steering assembly should be checked periodically for loose nuts and bolts, worn tie rod ends, worn boots, and other damage. Check the routing of all cables, hoses, and wires to be sure that the steering mechanism is not restricted or limited. If any abnormalities are found **do not attempt to operate the vehicle**, contact an authorized dealer or service center to have the vehicle inspected and serviced.

The steering assembly should also be checked periodically for to ensure it moves freely and is able to move freely through its entire range of motion without binding.

Lubricate the Pivoting Parts

Recommended lubricant:
Lithium soap-based grease

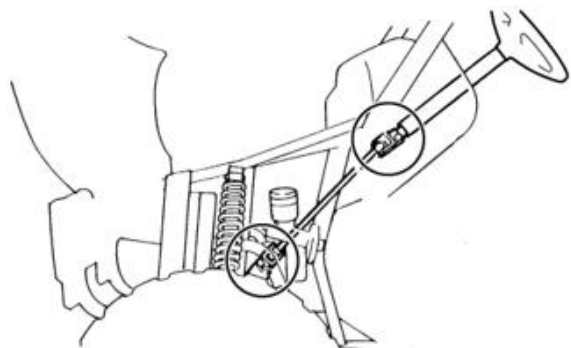

10.7 Camber and Caster

The camber and caster are not adjustable on this vehicle.

10.8 Toe Alignment Check

The recommended toe alignment is 1/8" to 1/4"(3 to 6 mm) toe out.

1. Set the steering wheel so that the wheels are facing straight ahead
2. Measure A and B, A minus B should be 1/16" to 1/8" (1.5 to 3 mm).
3. If this measurement needs to be adjusted, contact an authorized dealer or service center for service.

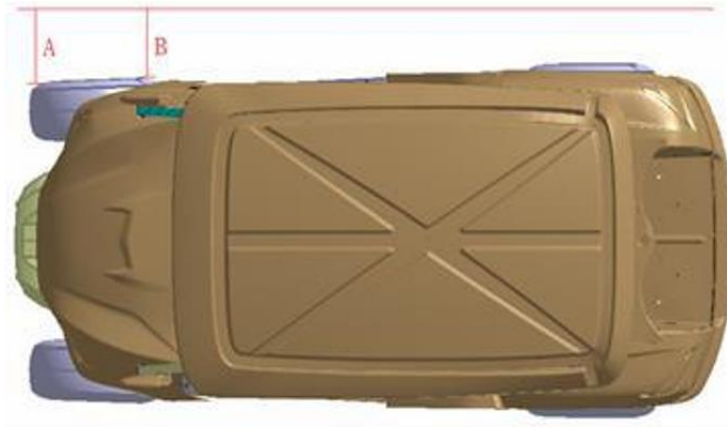

WARNING

Do not attempt to adjust the tie rod for toe alignment. The toe alignment must be adjusted by an authorized dealer or service center. Improper adjustments could result in serious injury or death.

10.9 Brakes



WARNING

Do not store or use a partial bottle of brake fluid. After using the necessary amount of brake fluid, discard the rest. Brake fluid is hygroscopic, meaning it rapidly absorbs moisture from the air. This lowers the boiling point of the brake fluid, which can cause early brake fade and could result in serious injury.

The following checks are recommended for keeping the braking system in good operating condition. The interval at which these checks should be performed depends on how the vehicle has been driven.

1. Use DOT 3 or DOT 4 brake fluid.
2. The fluid level in the master cylinder reservoir should be kept at the level described in section **9.4 Lubrication Recommendations**. It is normal for the diaphragm to extend into the reservoir as the fluid level drops. If the fluid level is low and the diaphragm is not extended, a leak is indicated, and the diaphragm should be replaced. To ensure proper operation of the diaphragm, the reservoir should be filled to the appropriate level each time after the cover is loosened or removed.
3. Check the braking system for fluid leaks. Depress the brake pedal to check for excessive travel or a spongy feel.

Front Brakes

The front brakes on this vehicle are hydraulic disc brakes, which are employed simultaneously with the rear brakes by depressing the brake pedal. The front brakes are self-adjusting and therefore do not require adjustment.

Check the condition of the hydraulic disc brakes

1. Check the brake pads for wear, damage, or looseness
2. Check that the brake rotor is secure, and its surface is in good condition
3. Brake pads should be changed when the thickness reaches 3/64" (1mm)
(See item A in the diagram to the right)

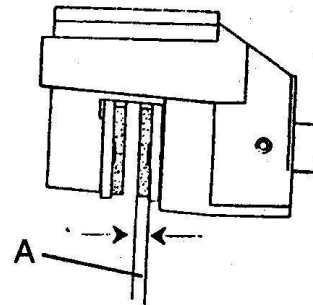
**Rear Brakes**

The rear brakes on this vehicle are hydraulic drum brakes, which are employed simultaneously with the front brakes when the brake pedal is depressed. The rear brakes are self-adjusting and therefore do not require adjustment.

Parking Brake

The parking brake is internal to the rear hydraulic drum brakes and is operated by the parking brake pedal via a parking brake cable.

10.10 Storage

It is not recommended for the vehicle's batteries to be stored for an extended period of time without charging. It is important to ensure that the battery is adequately charged before it is stored, and be mindful of the state of charge (SOC) of the batteries and prevent the SOC from dropping below 30%. The 12V starting battery must either be checked once a week and topped off or connected to battery maintainer that is appropriate for the battery type. Lithium batteries do not need to be connected to a battery maintainer.

The vehicle should be driven once a week or elevated on blocks to ensure that the tires do not develop flat spots.

11. Cleaning the Vehicle

11.1 Exterior Body Panels

The body panels on this vehicle should be handwashed using a commercially available automotive cleaner and a soft sponge or cloth intended for automotive use. A hose with residential water pressure set to a shower or mist setting may be used to rinse the vehicle.

Before spraying the exterior of the vehicle with water, always ensure that the charging socket cover is firmly in place and the front and rear under-seat compartments are closed. Do not attempt to power wash or pressure wash this vehicle, as the higher water pressure can compromise the seals on the vehicle and allow water to come in contact with electrical components.



WARNING

Water that comes in contact with the battery or electrical components could cause short circuits, burn electrical circuits or components, cause fire or leakages, or cause other issues that could result in serious injury or death.

11.2 Seats and Floorboard

The seats and floorboard of this vehicle should be wiped down or spot cleaned with a diluted mild detergent and a soft cloth. Excessive or caked dirt should first be removed by using a soft brush. Detergents should be tested in an inconspicuous location before use to ensure that they are compatible with the seat material.

11.3 Windshield and Lights

The windshield, headlights, and taillights may be cleaned with a diluted mild detergent and a soft cloth. It is not recommended to use glass cleaner on any clear plastic components, as this can cause irreparable damage to the plastic.

11.4 Wheels and Tires

The wheels and tires may be cleaned with commercially available wheel and tire cleaners. When using these cleaners, ensure that they do not come in contact with the plastic components or body panels on the vehicle, as this could cause irreparable damage.

NOTE: Wet brakes have reduced stopping ability. Always test the brakes after washing the vehicle and, if necessary, apply the brakes lightly several times to allow friction to dry out the brake pads.

11.5 Front Basket

The front basket should be wiped down using a diluted mild detergent and a soft cloth.

11.6 Under-Seat Compartments

Mud, dust, or dirt on the inside walls of the compartments under the front and rear seats should be removed using a stiff brush and wiped down with a dry cloth. Do not spray water in the under-seat compartments, as the water will come in contact with the battery and the vehicle's electrical components, and could cause short circuits, burn electrical circuits or components, cause fire or leakages, or cause other issues that could result in serious injury or death.



WARNING

Do not spray water in the compartments under the front or rear seats. Water that comes in contact with the battery or electrical components could cause short circuits, burn electrical circuits or components, cause fire or leakages, or cause other issues that could result in serious injury or death.

12. Transporting the Vehicle



CAUTION

This vehicle is not designed to be transported at speeds exceeding 20 mph. Transporting this vehicle in an enclosed trailer is highly recommended.

If this vehicle is transported on an open trailer at speeds in excess of 20 mph, the owner does so at their own risk, and any resulting damage will not be covered under the vehicle warranty. The procedures outlined below are intended to minimize damage to a vehicle transported on an open trailer, but even if these procedures are followed, damage to the vehicle is still possible.

12.1 Strap Down the Roof

Use ratchet straps to secure the roof to the frame of the vehicle in multiple locations.



CAUTION

Towing this vehicle in an open trailer at speeds exceeding 20 mph without removing the windshield or without strapping down the roof could result in the roof being ripped from the vehicle frame.

12.2 Protect the Windshield

Removing the windshield while transporting the vehicle on an open trailer is the best practice. If the windshield is not removed, it must be secured to the vehicle using ratchet straps and covered with a padded protective layer in order to minimize damage caused by objects striking the windshield at high speed.



CAUTION

Towing this vehicle in an open trailer at speeds exceeding 20 mph without removing the windshield will likely result in damage to the windshield.

13. Troubleshooting

The following troubleshooting information is intended only as a reference and does not cover all possible issues that may be encountered. When necessary, please refer to the information provided in this owner's manual for inspection, adjustment, and replacement of parts.

13.1 Contacting an Authorized Dealer or Service Center

The Kandi America website has a dealer look up engine that includes authorized dealerships, service centers, and stores that sell Kandi vehicles. Please use the contact information to schedule any service requests. Please note that any services provided outside of the warranty process are not covered by Kandi.

13.2 Battery (12V) Troubleshooting

The 12V battery is located in the under-seat compartment.

Voltage Reference	
Above 10V	Battery is healthy
6V - 10V	Battery needs recharging
Below 6V	Battery likely needs replacement



Above 10V

- If vehicle doesn't start, charge the 12V battery
- If the vehicle still doesn't start, check the 40-amp fuse, if present

6V - 10V

- Recharge battery with Battery Tender or try to jump start
- Monitor the discharge rate, replace battery if it depletes in 1-2 days

Below 6V

- Replace the battery
- Recharging may help, but only temporarily

Replacing the 12V Battery

1. Remove the two long bolts with an 8mm wrench
2. Remove the battery hold down brackets
3. Disconnect the battery
 - a. First, disconnect the negative battery terminal
 - b. Then, disconnect the positive battery terminal
4. Remove the battery
5. Place the new battery into position, keeping the cable orientation the same as when the old battery was removed
6. Re-connect the battery terminals
 - a. First, connect the positive battery terminal
 - b. Then, connect the negative battery terminal
7. Secure the battery with the hold down bracket and bolts using an 8mm wrench and 8 lb-ft of torque

13.3 Symptoms and Possible Causes

The following list of possible causes of vehicle malfunctions is intended for reference only. Contact an authorized dealer or service center for proper diagnosis of the issue.

Symptom: Vehicle alarm sounds while in forward gear

The parking brake is likely engaged or was not fully released

1. Fully depress the parking brake
2. If fully depressing the parking brake in step 1 re-engaged the parking brake, fully depress the parking brake a second time to release the parking brake
3. If these steps did not turn off the vehicle alarm, contact an authorized dealer or service center to have the vehicle inspected and serviced

Symptom: Vehicle won't move**Vehicle lights and meter are working properly***Possible causes:*

- Faulty DC contact
- Wiring harness malfunction
- Motor controller malfunction
- Motor malfunction
- Electronic gear shift fault
- Gearbox malfunction
- Accelerator pedal or pedal sensor failure
- Accelerator pedal output signal is not accurate
- Parking brake has not been released

Symptom: vehicle won't move**Vehicle lights and meter are not working***Possible causes:*

- Main switch malfunction
- Burnt out, improper connection
- Wiring harness malfunction
- Battery power shortage or battery malfunction
- Motor controller malfunction
- Poor contact of electronic components or connections

Symptom: Poor charging performance*Possible causes:*

- Vehicle charger malfunction
- Charger body, charging cable assembly or socket malfunction
- Unreliable battery connection
- Battery malfunction

Symptom: Poor braking*Possible causes:*

- Worn out front hub bearing
- Worn brake pad
- Worn brake disc
- Air in brake fluid line
- Faulty master cylinder
- Faulty caliper seal
- Loose union bolt
- Broken brake hose
- Oily or greasy brake pad or brake disc

Operating performance issues

- Accelerator does not return to idle position
- Poor medium and high-speed performance

13.4 Fault Codes

The following list of fault code explanations is for reference only. Contact an authorized dealer or service center for proper diagnosis of the issue.

Fault Code	Description
3001	Individual over-voltage alarm
2002	Individual under-voltage alarm
3002	Individual under-voltage alarm
2003	Individual pressure excessive difference alarm
3004	Total voltage over-voltage alarm
2005	Total voltage under-voltage alarm
3005	Total voltage under-voltage alarm
2006	Battery cell high temperature alarm
3006	Battery cell high temperature alarm
2007	Battery cell low temperature alarm
2008	Temperature excessive difference alarm
2009	Discharge current exceeding limit alarm
3009	Discharge current exceeding limit alarm
2010	Recharge current exceeding limit alarm
3010	Recharge current exceeding limit alarm
2011	Current sensor fault
1015	Low battery SOC alarm
2015	Low battery SOC alarm

Fault Code	Description
3018	BMS internal communication fault
2030	Motor over temperature alarm
3030	Motor over temperature alarm
2031	Controller over temperature alarm
3031	Controller over temperature alarm
3032	Hardware overcurrent fault
3033	Software overcurrent fault
3034	Motor rotation failure
3035	Current sampling circuit fault
3036	Motor encoder fault
3037	MCU DC input terminal overvoltage alarm
3038	MCU DC input terminal undervoltage alarm
3039	CAN communication failure
3040	Motor over-speed alarm
3041	Temperature sensor fault

Vehicle Specifications

Length x Width x Height	119.5 x 53.5 x 81 in	303 x 135 x 205 cm
Wheelbase	68.5 in	173.5 cm
Ground Clearance	7 in	17.5 cm
Dry Weight	1184 lbs	537 kg
Max Load Capacity	882 lbs	400 kg
Towing Capacity	20% grade: 1720 lbs 30% grade: 1320 lbs	20% grade: 780 kg 30% grade: 600 kg
Front Tire	23 x 10.5-14	
Rear Tire	23 x 10.5-14	
Front Brakes	Hydraulic Disc Brake	
Rear Brakes	Hydraulic Drum Brake	
Front Suspension	MacPherson Independent Suspension	
Rear Suspension	Towing Arm Type Helical Spring Suspension	
Motor	5kW	
Battery	100 Ah / 52.1V	